

Article number: 20478B12M8MT

Description: E+G Clamp mounting - GN 478-B12-M8-MT

## Measures

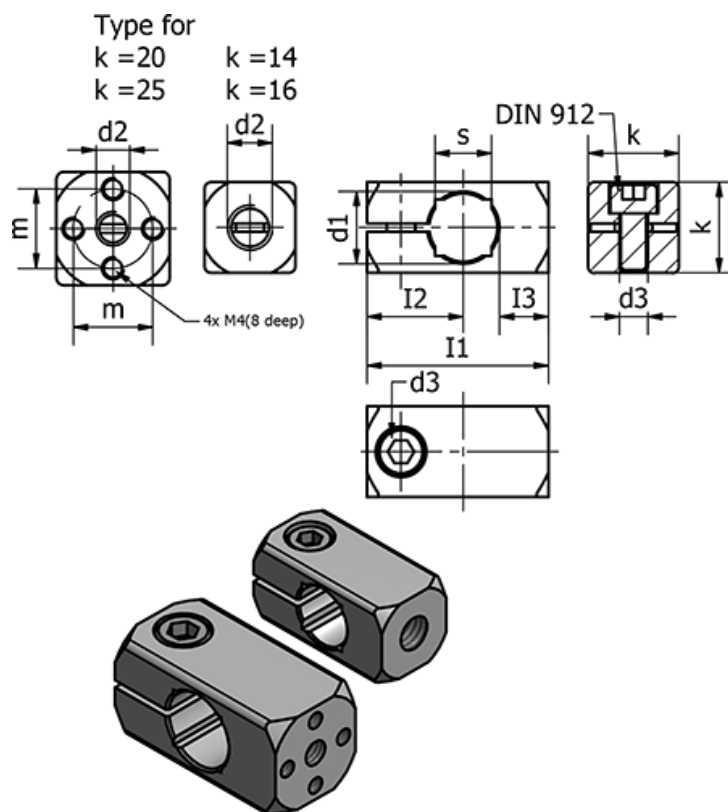

Clamping kit for d2 = GN 511-M5-16

d1 h11 = 12  
 d2 = M8  
 d3 = M5  
 I1 = 32  
 I2 = 17  
 I3 = 9  
 k = 16

m =  
 s = 10  
 Weight (g) = 15